



**O'REILLY**  
— OAKSTOWN —  
— ENVIRONMENTAL —



**OAKSTOWN  
BAF®**

 **Topline McKennas**

[www.oreillyoakstown.com](http://www.oreillyoakstown.com)

# TOTAL RELIABILITY

Established in 1972 and with over 50 years' experience, O'Reilly Oakstown Environmental have gone from strength to strength and are now the largest manufacturer of precast concrete domestic wastewater treatment systems in Ireland and the UK. During this time we have installed over 10,000 Oakstown BAF Wastewater Treatment Systems and 34,000 Septic Tanks with our reputation for reliability, quality and customer satisfaction being second to none.

Whether you are building a new home or upgrading an existing septic tank, our experienced sales and technical team will guide you through the entire process.

From our in-house design team to our experienced technicians we ensure every installation is carried out to the highest standards and is certified to current regulations.

We only use the highest quality components and materials ensuring a low maintenance lifelong solution.

## PRODUCT BENEFITS

- Large Capacity Tanks
- Robust, Reliable, Lifelong Solution
- Low Running Costs
- Only the highest quality components used
- Strength – Reinforced Precast Concrete
- 5 Chamber System
- Full Installation Service
- Certified to EN12566-3 and Compliant with SR66: 2015
- Discreet



# 4 STEPS TO THE PERFECT WASTEWATER SOLUTION



Please contact O'Reilly Oakstown Environmental for your free site survey.

P : 046 943 1389

E : [sales@oreillyoakstown.com](mailto:sales@oreillyoakstown.com)



Our experienced team will work closely with you to ensure your installation runs smoothly.



Once your system is installed and commissioned by our technical team, we will certify your wastewater treatment system in line with EN12566-3 and SR:66 2015.



We provide a dedicated customer support department with a range of customer service options available for both domestic and commercial systems.

# 6 PERSON WASTEWATER TREATMENT SYSTEM

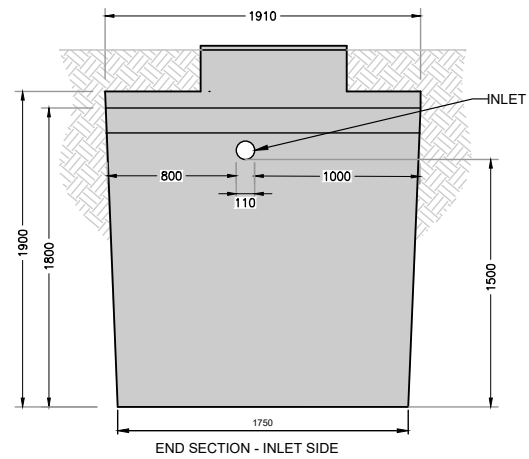
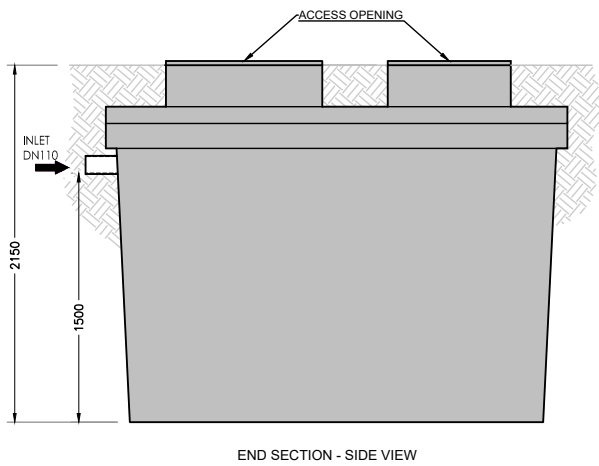

## LEGEND

- A..... Inlet pipe from dwelling
- B ..... Primary settlement
- C..... Bioreactor chamber
- D..... Clarifier chamber
- E..... Discharge chamber (by pump or gravity)
- F..... To percolation
- G .... Air compressor
- H .... Bio-media
- I..... Diffusers

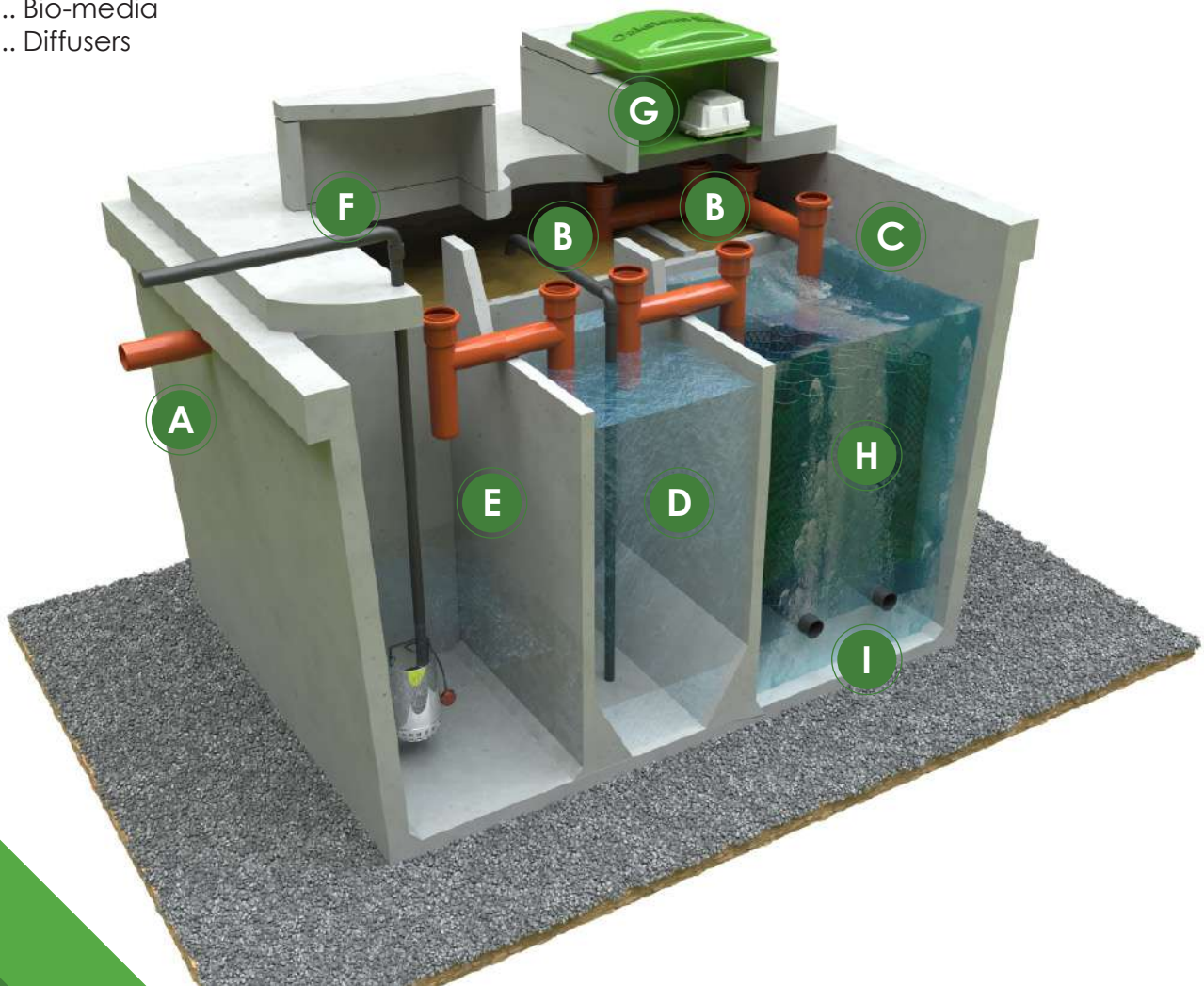

# 8 PERSON WASTEWATER TREATMENT SYSTEM

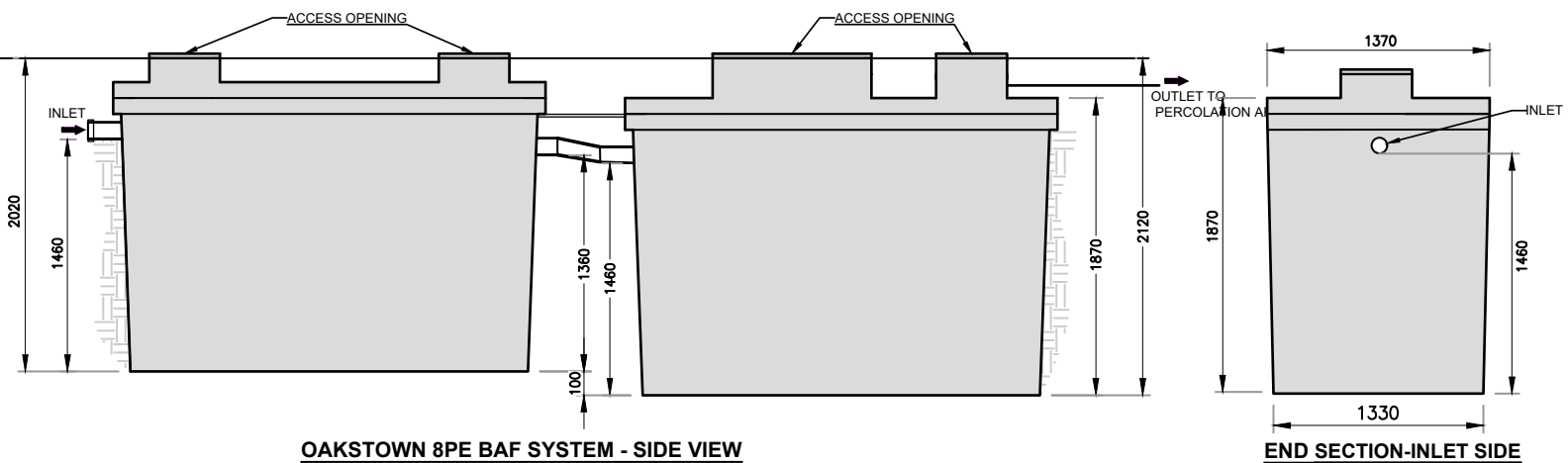

## LEGEND

- A..... Inlet pipe from dwelling
- B ..... Primary settlement
- C..... Bioreactor chamber
- D..... Clarifier chamber
- E..... Discharge chamber (by pump or gravity)
- F..... To percolation
- G .... Air compressor
- H..... Bio-media
- I..... Diffusers

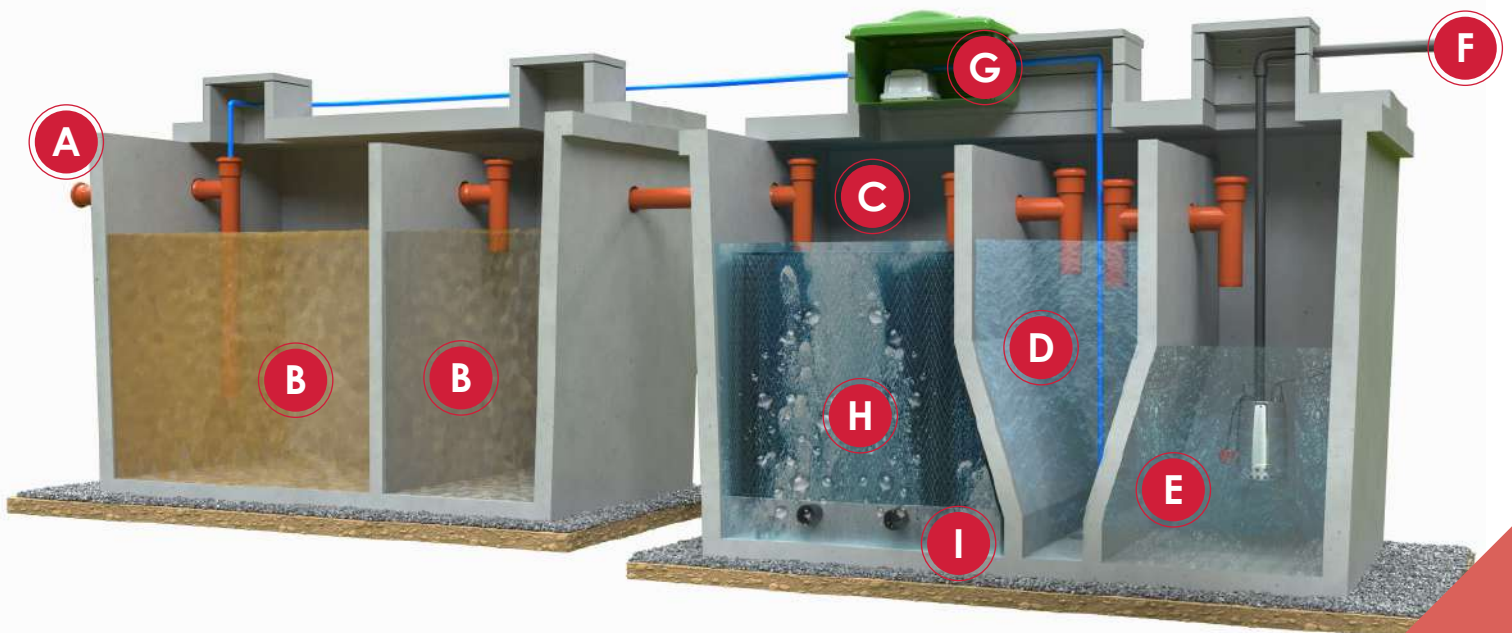
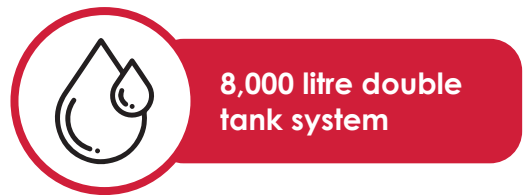

# HOW IT WORKS

The Oakstown wastewater treatment system uses BAF (Biological Aerated Filtration) Technology across its range of domestic and commercial treatment plants. BAF Technology is widely regarded as the most reliable, efficient and effective means of treating wastewater and due to its low maintenance requirements it ensures lifelong peace of mind.

Our systems comprise of 5 individual chambers which combine both anaerobic and aerobic digestion. This unique aspect to our system ensures unrivalled final effluent quality with low running costs.



## STAGE 1 - PRIMARY SETTLEMENT IN CHAMBERS 1 & 2

Primary Settlement works on the basis of sedimentation, where solids separate from the water in chambers 1 and 2 allowing for anaerobic digestion over an extended period of time.



## STAGE 2 - BIO REACTOR CHAMBER

Wastewater continues to flow by gravity into chamber 3 where natural occurring micro-organisms form on our submerged biofilm filter and are oxygenated by a small air blower. Effluent is extensively treated in this chamber prior to gravity flow into chamber 4.



## STAGE 3 - CLARIFIER CHAMBER

Final settlement takes place within our Clarifier Chamber where any remaining sediment gravitates to the bottom of the tank and is transferred back to the primary settlement chamber. This ensures only fully treated water enters the final chamber.



## STAGE 4 - DISCHARGE CHAMBER

Treated water is stored within the discharge chamber and can be pumped or gravity fed to the percolation area depending on the client's site requirements.

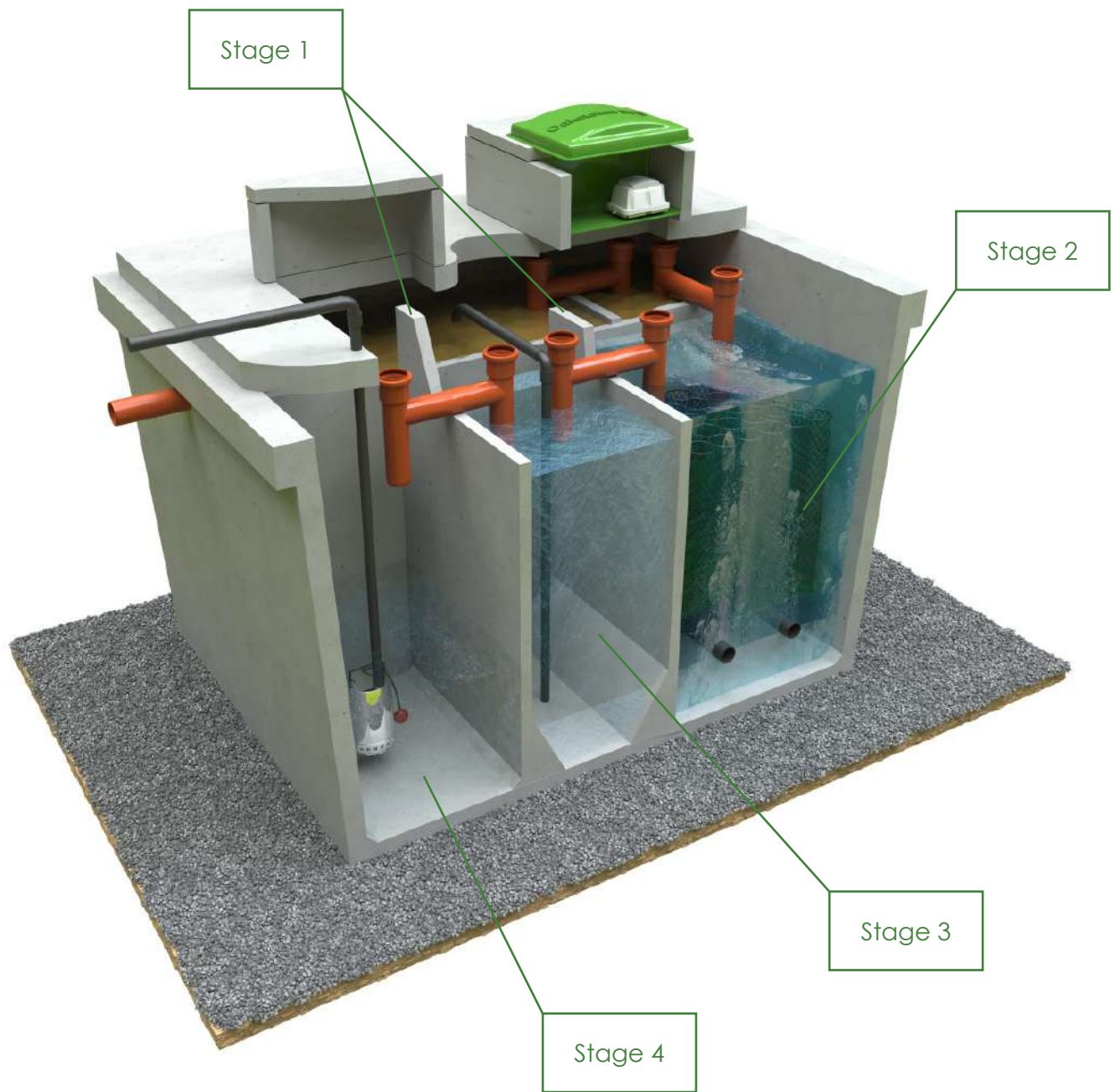

# WHY CHOOSE AN OAKSTOWN BAF SYSTEM ?



-  **Peace of Mind**  
We have over 50 years' manufacturing experience and knowledge of the wastewater industry with an unrivalled reputation for customer service and reliability.
-  **Low Maintenance Solution**  
Low running costs, less desludging & minimal moving parts.
-  **Ireland's Market Leader in Precast Domestic Wastewater Treatment Systems**  
Over 10,000 BAF Systems and 30,000 Septic Tanks installed across Ireland.
-  **Large Capacity**  
8 Person BAF (8,000 litre) / 6 Person BAF (6,700 litre) treated across 5 chambers
-  **Superior Quality Components**  
Stainless steel pump, high quality air compressor, armoured cable, monitoring panel with audible and visual alarm
-  **Quality**  
We manufacture all of our own precast concrete tanks in a factory-controlled environment.

# COMPANY BACKGROUND

O' Reilly Oakstown Environmental is part of the O' Reilly Group which is one of the largest precast manufacturers in Ireland and UK. The Group comprises of O' Reilly Concrete, O' Reilly Oakstown Environmental, Barleystone Paving and O' Reilly Precast, with 10 manufacturing facilities across Ireland and the UK.

Based in Trim, Co Meath, nestled in the heart of the beautiful and historic Boyne Valley we are naturally aware of the importance of effective treatment of wastewater to protect our environment. Since we began manufacturing septic tanks almost 50 years ago our core business has developed into what we like to term 'Environmental Precast Concrete.'



As part of our Green Strategy initiative we have planted almost 15,000 trees adjacent to our production facility which will absorb up to 170 tonnes of CO2 per year.



**Almost 15,000  
trees planted  
across 11 acres**



# PRODUCT RANGE

- Commercial Wastewater Treatment Systems from 20PE to 500PE
- Septic Tanks & Domestic Wastewater Treatment Systems
- Large Capacity Precast Concrete Storage Tanks
- Ultraflo Liquid Screed & Readymix Concrete
- Stormwater/Attenuation Solutions
- Rainwater Harvesting Systems
- Septic Tank Upgrades
- Oil/Water Separators
- Pumping Stations
- Firefighting Tanks
- L-Walls & A-Walls
- Cable Troughs
- Coco Filters



**Check out the  
Oakstown Online Shop!**

We stock a full range of components and accessories for our wastewater treatment systems on our online shop. Please visit

**[www.oreillyoakstown.com/shop](http://www.oreillyoakstown.com/shop)**



# O'REILLY GROUP : COMPANY BACKGROUND

The O'Reilly Group is made up of 4 companies: O'Reilly Concrete, Barleystone Paving, O'Reilly Oakstown Environmental and our newest addition, O'Reilly Precast in the UK. The Group has 10 production facilities dispersed between Ireland and the UK.

O'Reilly Concrete are leading manufacturers of precast products. Manufactured in Ireland, this efficient way of modular building has helped streamline the construction process. Our rapid build system is utilised in a range of construction activities, ranging from residential house and office blocks to sports arenas and transport projects. These modern methods of construction have proved innovative and time saving, whilst always maintaining high standards in quality. O'Reilly Precast is the Group's UK precast manufacturing company.

Barleystone Paving offer a wide range of paving for 'The Perfect Finish'. We are committed to offering superior quality products, trusted technical advice and on-time delivery service. Barleystone can transform your driveway or garden into a stunning area for a homeowner to be proud of.

When your Oakstown BAF System is fully installed, Barleystone Paving is the next step for you, blending your BAF System neatly and discreetly to the beautiful landscape.

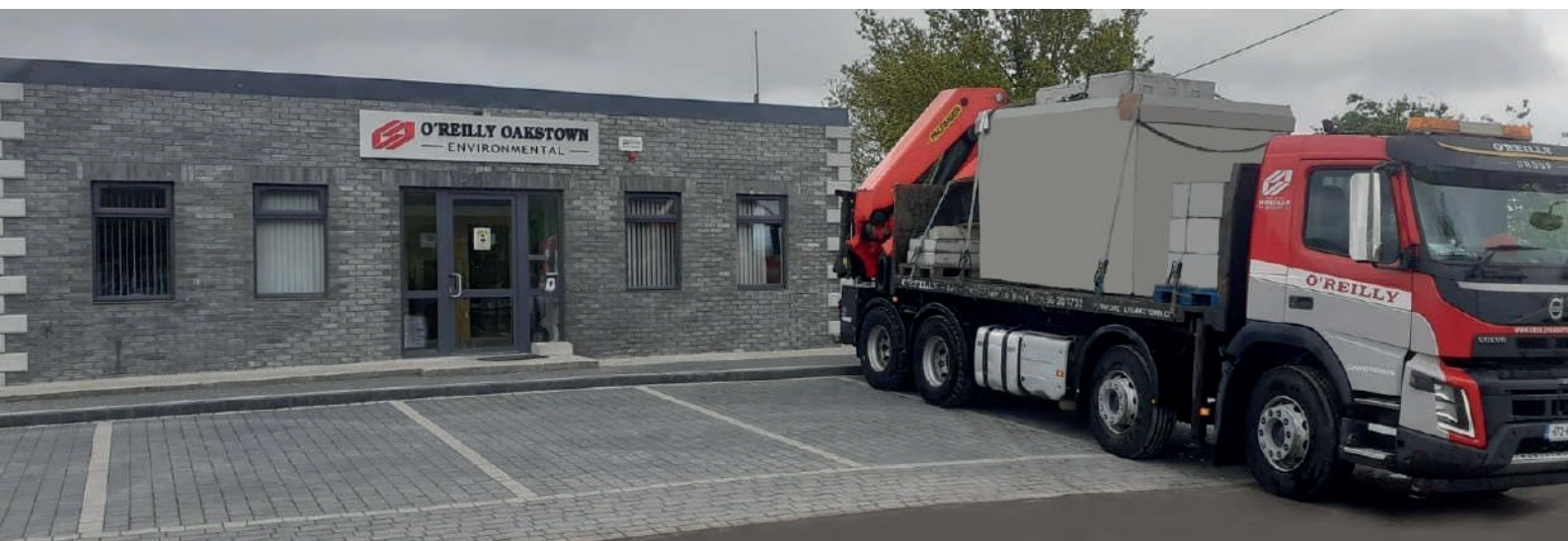



# Topline McKennas



JOHN B. KEANE ROAD  
LISTOWEL, CO. KERRY

Call 068 21044

[WWW.MCKENNAS.IE](http://WWW.MCKENNAS.IE)

*Agents for  
Kerry &  
Limerick*

OAKSTOWN  
BAF®

*Ireland's Market Leader\**

## **WASTEWATER TREATMENT SYSTEMS**

\* Precast Domestic Wastewater Treatment Systems  
Over 10,000 BAF Systems & 30,000 Septic Tanks installed

**QUALITY & SERVICE SINCE 1871**



Paint & Décor

Building & DIY

Heating & Bathroom

Indoor & Outdoor Living

Doors & Floors